

# 江西省晶能半导体有限公司

JiangXi LatticePower Semiconductor Corporation

## 产 品 规 格 书 Specification

产品名称 <b>Product Name:</b>	<u>        <b>HFL1-R</b>        </u>
产品型号 <b>Product P/N:</b>	<u>        <b>A7</b>        </u>
客 户 <b>Client name:</b>	<u>                                </u>
客户料号 <b>Client P/N:</b>	<u>                                </u>
版本号 <b>Version No.:</b>	<u>        <b>A01</b>        </u>
日 期 <b>Sending Date:</b>	<u>        <b>2023.12</b>        </u>

客户承认栏 <b>Client Approval</b>	
核准 <b>Approval</b>	确认 <b>Audit</b>

制定 **Confirmation:** \_\_\_\_\_ 审核 **Approval:** \_\_\_\_\_

工厂地址:江西省南昌市高新区艾溪湖北路 699 号

Address: No.699 Aixihu North Road, Nanchang, Jiangxi Province, China



# 目录 Contents

1、特点 Features .....	1
2、应用 Applications .....	1
3、性能 Performance .....	2
4. 产品代码 Product Order Code .....	4
5. 分档规则 Bin Regulations .....	5
6、光电特性图.....	6
7. 产品及钢网尺寸 Product and PCB Pad Dimensions.....	7
8、回流焊特性 Reflow Soldering Characteristics .....	8
9、载带及卷轴 Reel Dimensions .....	9
10、可靠性 Reliability.....	10
11、注意事项 Cautions.....	11
12、文件履历 Document Resume .....	12

## 1、特点 Features

- ◆ 陶瓷封装，高亮度，高可靠性  
Ceramic Substrate package , High brightness ,High reliability
- ◆ 尺寸：2.04mm\*1.64mm\*0.85mm  
Size: 2.04mm\*1.64mm\*0.85mm
- ◆ 根据白光标准分档  
According to standard white color gamut
- ◆ 适于 SMT 贴片  
Compatible with SMT
- ◆ 发光角度：120°  
Viewing Angle: 120°
- ◆ 包装：最大 3000 颗/卷  
Package: Max: 3000pcs /reel
- ◆ 建议额定使用电流为 350mA  
Recommended current 350mA

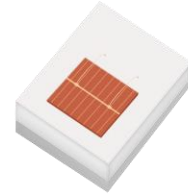

## 2、应用 Applications

汽车照明	Automobile
摩托车照明	Motorcycle
非机动车	Non-motorized vehicle



### 3、性能 Performance

#### a) 绝对最大额定值 Absolute Maximum Ratings

参数 Parameter	符号 Symbol	最大参数值 Maximum Rating	单位 Unit
电流 DC (Video Mode) Forward Current	$I_F$	700	mA
功率 Power Dissipation	P	1.5	W
脉冲电流 Pulsed(Flash Mode) Forward Current	$I_{FP}$	800	mA
结温 (DC 模式) LED Junction Temperature(DC mode)	$T_j$	125	°C
工作温度 Operating Temperature Range	$T_{opr}$	-40~105	°C
存储温度 Storage Temperature	$T_{stg}$	-40~120	°C

备注 Notes :

- ◇ 绝对最大额定值环境温度  $T_a=25^{\circ}\text{C}$   
Absolute Maximum Ratings at  $T_a=25^{\circ}\text{C}$
- ◇  $I_{FP}$  脉冲时间 $\leq 10\text{ms}$ , 宽度 $\leq 10\%$   
 $I_{FP}$  Conditions with pulse width  $\leq 10\text{ms}$  and duty cycle $\leq 10\%$

## b) 光电参数

### Electro-Optical Characteristics (T solder pad =25 °C, I<sub>F</sub> =350mA)

项目 Item	符号 Symbol	最小值 Min.	典型值 Typ.	最大值 Max.	单位 Unit
光通量 Luminous Flux	Φ	51.7	65	73.9	Lm
正向电压 Forward Voltage	VF	1.90	2.30	2.65	V
主波长 Dominant wavelength	WLD	615	620	625	nm
热阻 Thermal Resistance	----	----	4.5	----	°C/W
发光角度 Viewing Angle	2θ1/2	----	120	----	°
结温 LED Junction Temperature	T <sub>j</sub>	----	125	----	°C

### c) 亮度分布特性 Luminous Flux Characteristics (T solder pad = 25 °C, I<sub>F</sub> =350mA)

Product	WLD	Luminous Code	Luminous Flux		Order Code (e. g.)
			min	max	
A7	615~620	N2	51.7	56.8	A7-R2-N3-FG2
		N3	56.8	62.0	
		N4	62.0	67.2	
		P2	67.2	73.9	
	620~625	N2	51.7	56.8	A7-R3-N3-FG2
		N3	56.8	62.0	
		N4	62.0	67.2	
		P2	67.2	73.9	

备注 Notes :

◇ 光通量测量误差范围±6%

Luminous flux measurement tolerance: ±6%

◇ 光电参数测试是瞬态时间为 50ms

Electric and optical data is tested at 50 ms pulse condition

## 4. 产品代码 Product Order Code

A7 - R3 - N3 - FG2  
①                      ②                      ③                      ④

- ① 产品型号      Product Type (A7:HFL1-R)
- ② 主波长        Dominant wavelength
- ③ 亮度等级      Brightness Level
- ④ 电压等级      VF Level

出货标签(例) Shipping label (e.g.)



**LatticePower Corporation Limited**

Item: A7-R3-N3-FG2      HFL1-R



Reel ID: AA7C00000001



Qty: 3000

6A7XBACA



Date:2023-12-15

## 5. 分档规则 Bin Regulations

### a) 主波长分档 Dominant wavelength Groups

Group Code	Min.	Max.
R2	615	620
R3	620	625

### b) 亮度分档 Luminous Flux Groups

Group Code	Min.	Max.
N2	51.7	56.8
N3	56.8	62.0
N4	62.0	67.2
P2	67.2	73.9

### c) 电压分档 Voltage Groups

Group Code	Range
FG1	1.90~2.05
FG2	2.05~2.20
FG3	2.20~2.35
FG4	2.35~2.50
FG5	2.35~2.65

备注 Notes :

- ◇ 亮度测试存在±6%的公差  
It maintains a tolerance of ±6% on luminous flux measurements.
- ◇ 电压测试误差±0.1V  
Forward voltage(VF) ± 0.1V

## 6、光电特性图

### The Photoelectric Characteristics Graph (Ta= 25 °C)

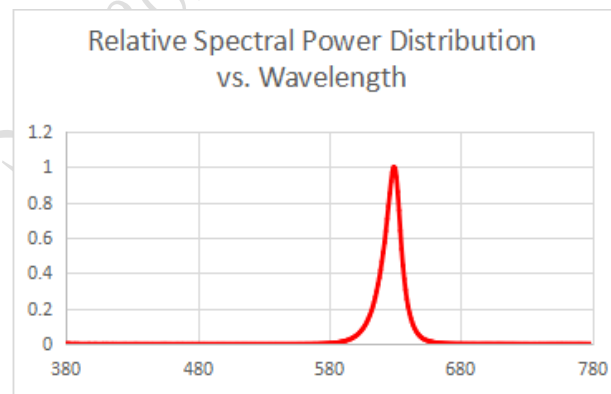
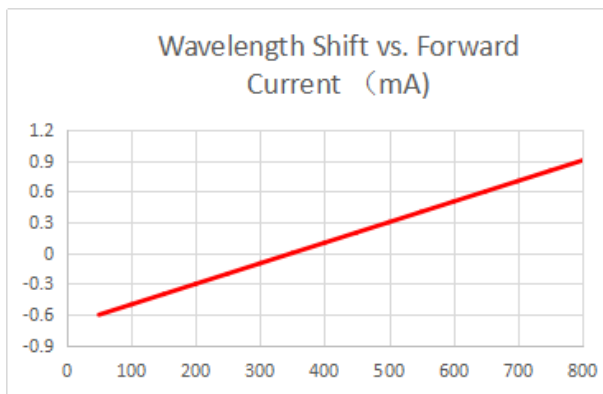
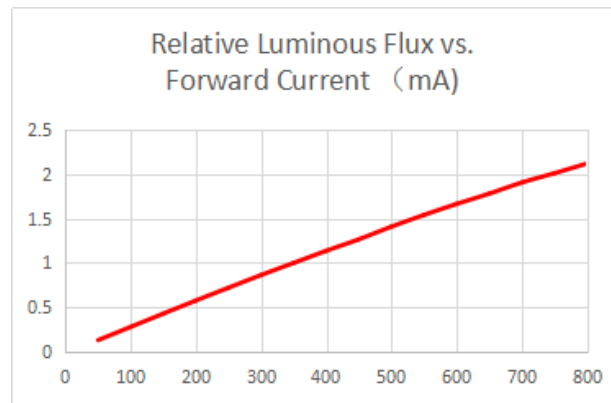
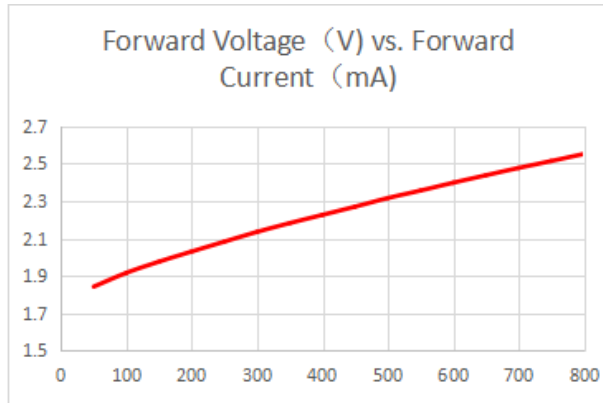



## 7. 产品及钢网尺寸 Product and PCB Pad Dimensions

### a) 产品尺寸 Product Dimensions:

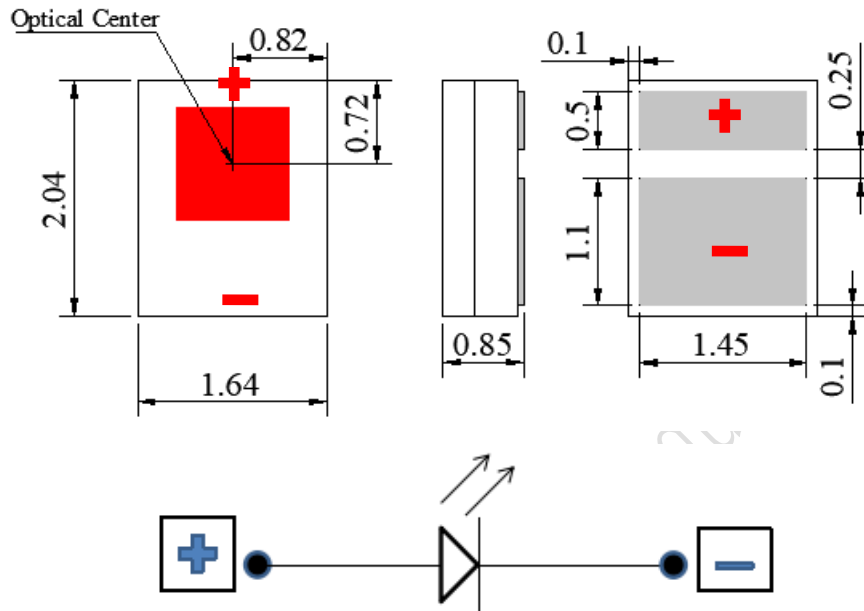

### b) 推荐焊盘尺寸 PCB Pad Dimensions

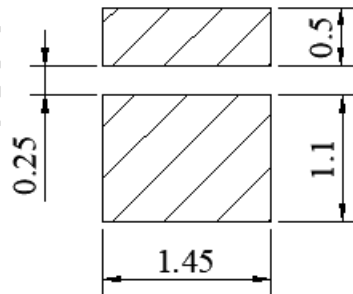

#### 备注 Notes:

- ◇ 所有尺寸均以 mm 为单位  
All dimensions are in millimeters
- ◇ 尺寸未按照公差±0.1mm 标记的，按照图纸标记  
Size is not marked in accordance with tolerance  $\pm 0.1\text{mm}$  and dimension tolerances in accordance with drawings

## 8、回流焊特性 Reflow Soldering Characteristics

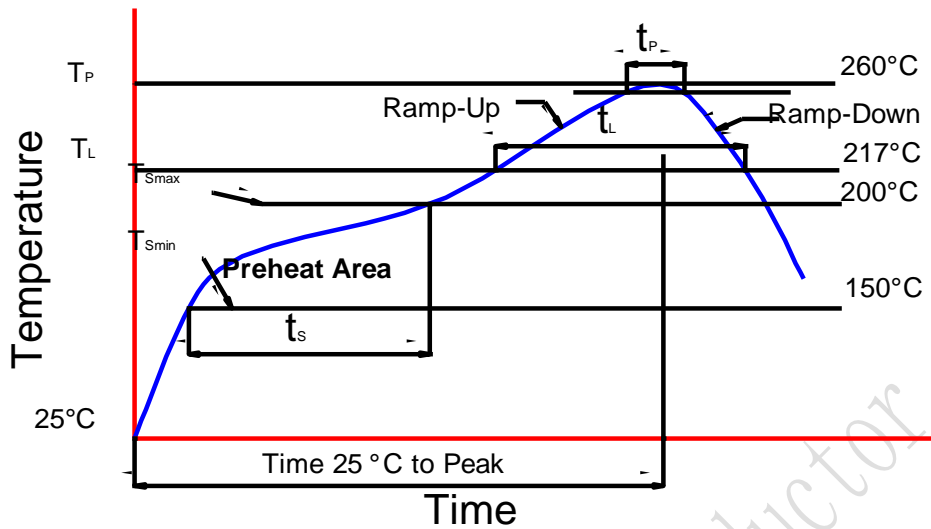

根据 EDEC-J-STD-020D 内容，参考以下内容。

Compatible with the JEDEC-J-STD-020D, using the parameters listed below.

特制参数 Profile Feature	无铅焊料 Lead-Free Solder
平均上升速率 (T <sub>smax</sub> 至 T <sub>p</sub> ) Average Ramp-Up Rate (T <sub>smax</sub> to T <sub>p</sub> )	3 °C/sec max.
预热: 温度最小值 (T <sub>smin</sub> ) Preheat: Temperature Min (T <sub>smin</sub> )	150
预热: 最高温度 (T <sub>smax</sub> ) Preheat: Temperature Max (T <sub>smax</sub> )	200
预热: 时间 (t <sub>smin</sub> 到 t <sub>smax</sub> ) Preheat: Time (t <sub>smin</sub> to t <sub>smax</sub> )	60-180 secs
回流温度 (T <sub>L</sub> ) Time Maintained Above: Temperature (T <sub>L</sub> )	217°C
回流时间 (t <sub>L</sub> ) Time Maintained Above: Time (t <sub>L</sub> )	60-150 secs
峰值/分类温度 (T <sub>p</sub> ) Peak/Classification Temperature (T <sub>p</sub> )	255 ± 5°C
实际峰值温度 (t <sub>p</sub> ) 在 5°C 以内的时间 Time Within 5°C of Actual Peak Temperature (t <sub>p</sub> )	20~40 secs
降低速率 Ramp-Down Rate	4°C/sec max.

## 9、载带及卷轴 Reel Dimensions

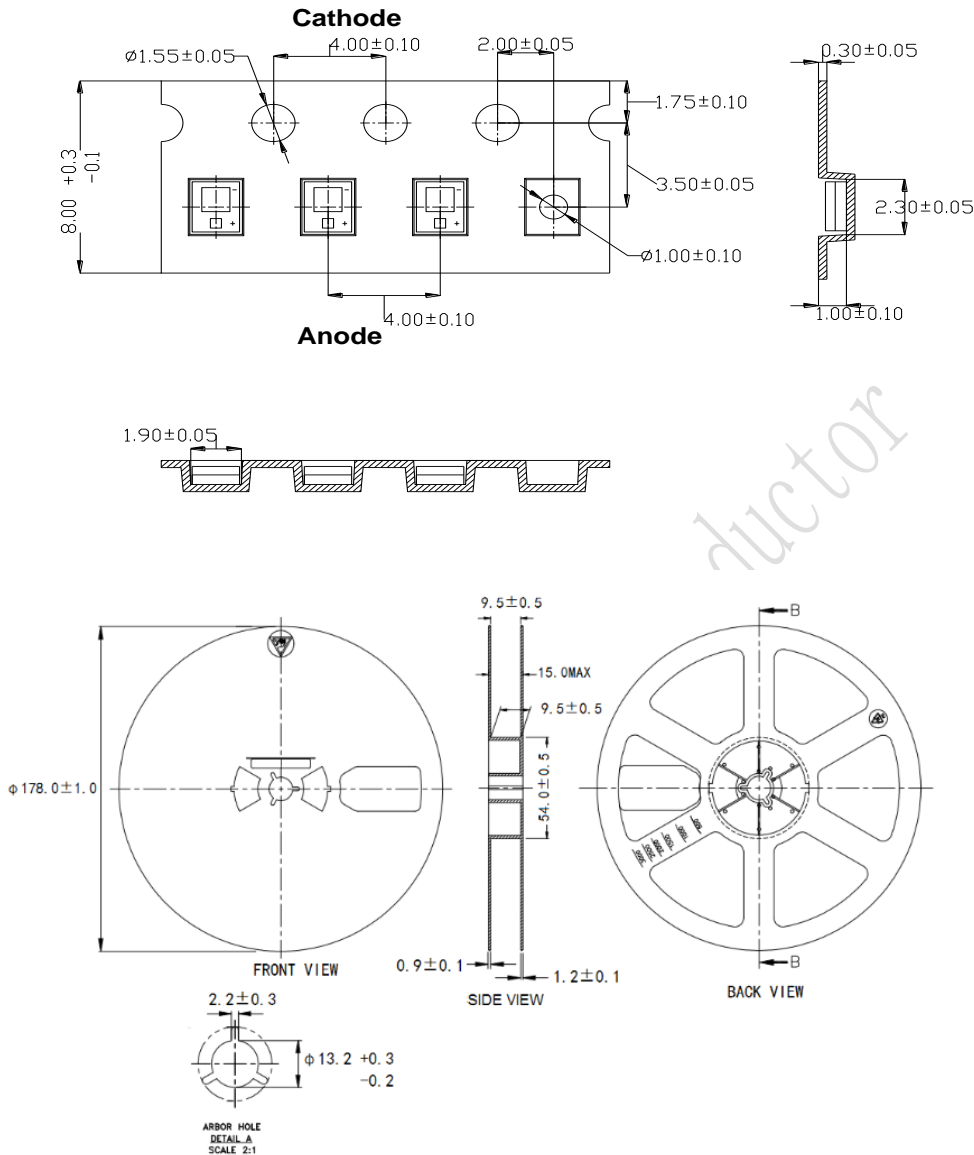

### 备注 Notes:

- ◇ 卷轴包装 3000pcs  
Reel:3000pcs.
- ◇ 卷轴包装方法符合 IJSC0806 (连续胶带上的电子元件包装)  
The tape packing method complies with IJSC0806(Packing of Electronic Components on Continuous Tapes).
- ◇ 当卷轴由于工作中断而重绕时, 载带上压力不应超过 10N, 否则 LED 可能会粘在盖带上  
When the tape is rewound due to work interruptions, no more than 10N should be applied to the embossed carrier tape.  
The LEDs may stick to the cover tape.

## 10、可靠性 Reliability

### a) 测试和结果 Tests and Results

测试项目 Test Item	标准 Reference Standard	测试条件 Test Conditions	测试周期 Test Duration
回流焊 Solderability(Reflow Soldering)	JESD22-B102	Tsld=255±5℃,5sec,Lead-free Solder (Sn-3.0Ag-0.5Cu)	3 times
高低温循环 Temperature Cycle	JESD22-A105	I <sub>F</sub> =700mA, -40℃(30min)~85℃(30min)	200cycles
冷热冲击 Thermal Shock	JESD22-A106	-40℃(15min)~125℃(15min)	200cycles
低温存储 Low Temperature Storage	JESD22-A119	T <sub>A</sub> =-40℃	1000H
高温老化 High Temperature Operating Life	JESD22-A108	T <sub>j</sub> =150℃, I <sub>F</sub> =700mA	1000H
高温高湿 Temperature Humidity Operating Life	JESD22- A101	T <sub>a</sub> =85℃, RH=85%, I <sub>F</sub> =700mA	1000H
震动 Vibration	JESD22-B103	10m/s <sup>2</sup> ,100~20000~100Hz,4cycles,4min, each X,Y,Z	3 times

## 11、注意事项 Cautions

### a) 存储 Storage

- 不要将芯片放在潮湿的地方，存放温度在 5°C~30°C之间，相对湿度在 30%以下。  
Do not place the chips in damp places, Storage temperature between 5 °C and 30 °C, Relative humidity under 30%.
- 开包后建议在 24 小时内过完回流焊，车间条件≤30°C/60%RH。  
After opening the package, it is recommended to finish the reflow within 24 hours. The workshop conditions are ≤30°C/60%RH
- 如果受潮，需将贴片卷盘放入 60°C烤箱烘烤 24 小时；打开后，LED 灯可重新密封在原始真空袋中。  
If it is wet, the patch reel should be baked in a 60 ° C oven for 24 hours; after opening, the LED light can be resealed in the original vacuum bag.
- 不要接触任何未知的液体，特别是丙酮。  
Don't touch any unknown liquid, In particular, acetone.
- 防止静电死亡，手动操作需要戴橡胶手套并佩戴静电环。  
Prevent electrostatic killed, Manual operation is required to wear rubber gloves and wear electrostatic ring.

### b) 清洗 Cleaning

- 通常，LED 不建议对部件进行湿式清洁处理，因为封装不是密封的。  
In general, LED does not recommend a wet cleaning process for component as the package is not hermetically sealed.
- 由于采用开放式设计，所有类型的清洁液都可能渗透到封装中，导致 LED 退化或完全失效。  
Due to the open design, all kind of cleaning liquids can infiltrate the package and cause a degradation or a complete failure of the LED.

### c) 操作注意 Handling Precautions

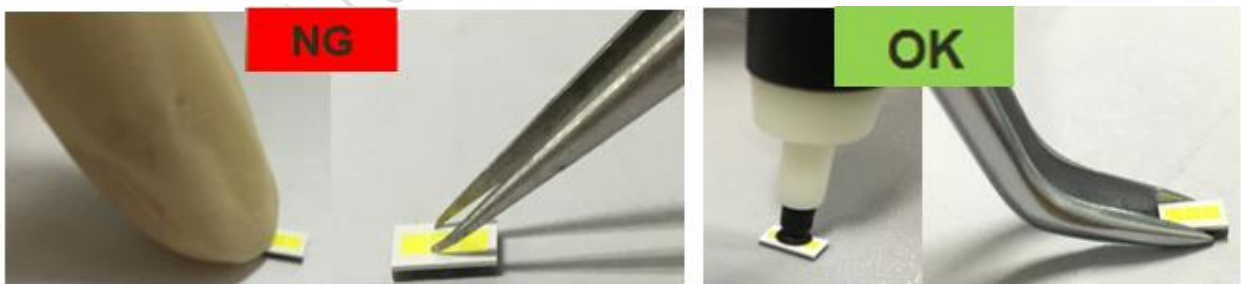

- 在处理过程中，还应注意确保组件顶面没有压力。  
During the handling, care should be taken as well to ensure no pressure on the top surface of component.
- 应避免使用尖锐物体（例如镊子，指甲等），以防止对硅树脂造成压力，因为这会导致部件损坏。  
All types of sharp objects(e.g. forceps, fingernail, etc) should be avoided in order to prevent stress to the silicone, since this can lead to damage of the component.

## 12、文件履历表 Document Resume

序号	变更日期	变更人	版本	变更内容
01	2021.03.09	李雄斌	Y00	1. 新制定
02	2021.06.01	李雄斌	A00	1.新增电压档位 FG5
03	2023.12.15	袁丁	A01	1.更新公司标签抬头;